



Ultra-Small, Rail-to-Rail I/O with Disable, Single-/Dual-Supply, Low-Power Op Amps

General Description

The MAX4245/MAX4246/MAX4247 family of low-cost op amps offer rail-to-rail inputs and outputs, draw only 320 μ A of quiescent current, and operate from a single +2.5V to +5.5V supply. For additional power conservation, the MAX4245/MAX4247 offer a low-power shutdown mode that reduces supply current to 50nA, and puts the amplifiers' outputs in a high-impedance state. These devices are unity-gain stable with a 1MHz gain-bandwidth product driving capacitive loads up to 470pF.

The MAX4245/MAX4246/MAX4247 family is specified from -40°C to +125°C, making them suitable for use in a variety of harsh environments, such as automotive applications. The MAX4245 single amplifier is available in ultra-small 6-pin SC70 and space-saving 6-pin SOT23 packages. The MAX4246 dual amplifier is available in 8-pin SOT23, SO, and μ MAX[®] packages. The MAX4247 dual amplifier comes in a tiny 10-pin μ MAX package.

Applications

Portable Communications
Single-Supply Zero-Crossing Detectors
Instruments and Terminals
Electronic Ignition Modules
Infrared Receivers
Sensor-Signal Detection

Selector Guide

PART	AMPLIFIERS PER PACKAGE	SHUTDOWN MODE
MAX4245AXT-T	1	Yes
MAX4245AUT-T	1	Yes
MAX4246AKA-T	2	No
MAX4246ASA	2	No
MAX4246AUA	2	No
MAX4247AUB	2	Yes

μ MAX is a registered trademark of Maxim Integrated Products, Inc.

Features

- ◆ Rail-to-Rail Input and Output Voltage Swing
- ◆ 50nA (max) Shutdown Mode (MAX4245/MAX4247)
- ◆ 320 μ A (typ) Quiescent Current Per Amplifier
- ◆ Single +2.5V to +5.5V Supply Voltage Range
- ◆ 110dB Open-Loop Gain with 2k Ω Load
- ◆ 0.01% THD with 100k Ω Load
- ◆ Unity-Gain Stable up to C_{LOAD} = 470pF
- ◆ No Phase Inversion for Overdriven Inputs
- ◆ Available in Space-Saving Packages
 - 6-Pin SC70 or 6-Pin SOT23 (MAX4245)
 - 8-Pin SOT23/SO or 8-Pin μ MAX (MAX4246)
 - 10-Pin μ MAX (MAX4247)

Ordering Information

PART	TEMP RANGE	PIN-PACKAGE	TOP MARK
MAX4245AXT-T	-40°C to +125°C	6 SC70-6	AAZ
MAX4245AUT-T	-40°C to +125°C	6 SOT23-6	AAUB
MAX4246AKA-T	-40°C to +125°C	8 SOT23-8	AAIN
MAX4246ASA	-40°C to +125°C	8 SO	—
MAX4246AUA	-40°C to +125°C	8 μ MAX	—
MAX4247AUB	-40°C to +125°C	10 μ MAX	—

Pin Configurations

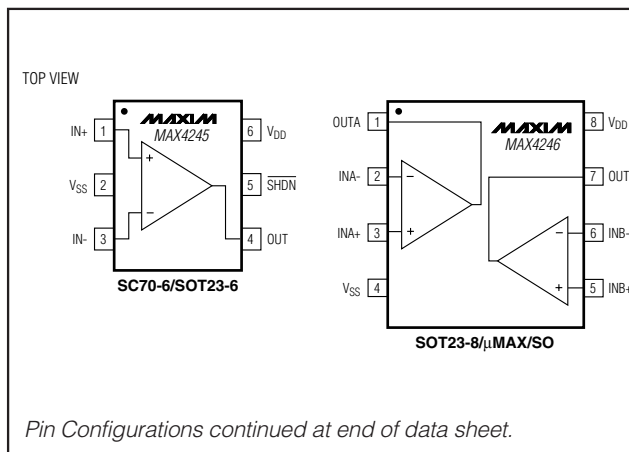

Ultra-Small, Rail-to-Rail I/O with Disable, Single-/Dual-Supply, Low-Power Op Amps

ABSOLUTE MAXIMUM RATINGS

Power-Supply Voltage (V_{DD} to V_{SS}).....	-0.3V to +6V	8-Pin SOT23 (derate 9.1mW/°C above +70°C).....	727mW
All Other Pins	($V_{SS} - 0.3V$) to ($V_{DD} + 0.3V$)	8-Pin μ MAX (derate 4.5mW/°C above +70°C)	362mW
Output Short-Circuit Duration (OUT shorted to V_{SS} or V_{DD}).....	Continuous	10-Pin μ MAX (derate 5.6mW/°C above +70°C)	444mW
Continuous Power Dissipation ($T_A = +70^\circ\text{C}$)		Operating Temperature Range	-40°C to +125°C
6-Pin SC70 (derate 3.1mW/°C above +70°C).....	245mW	Junction Temperature	+150°C
6-Pin SOT23 (derate 8.7mW/°C above +70°C).....	695mW	Storage Temperature Range	-65°C to +160°C
8-Pin SO (derate 5.9mW/°C above +70°C).....	471mW	Lead Temperature (soldering, 10s)	+300°C

Stresses beyond those listed under "Absolute Maximum Ratings" may cause permanent damage to the device. These are stress ratings only, and functional operation of the device at these or any other conditions beyond those indicated in the operational sections of the specifications is not implied. Exposure to absolute maximum rating conditions for extended periods may affect device reliability.

ELECTRICAL CHARACTERISTICS

($V_{DD} = +2.7V$, $V_{SS} = 0V$, $V_{CM} = 0V$, $V_{OUT} = V_{DD} / 2$, R_L connected from OUT to $V_{DD} / 2$, $\overline{SHDN}_- = V_{DD}$ (MAX4245/MAX4247 only), $T_A = +25^\circ\text{C}$, unless otherwise noted.) (Note 1)

PARAMETER	SYMBOL	CONDITIONS	MIN	TYP	MAX	UNITS
Supply Voltage Range	V_{DD}	Inferred from PSRR test	2.5		5.5	V
Supply Current (Per Amplifier)	I_{DD}	$V_{DD} = +2.7V$		320	650	μA
		$V_{DD} = +5.5V$		375	700	
Supply Current in Shutdown	$I_{\overline{SHDN}_-}$	$\overline{SHDN}_- = V_{SS}$ (Note 2)		0.05	0.5	μA
Input Offset Voltage	V_{OS}	$V_{SS} - 0.1V \leq V_{CM} \leq V_{DD} + 0.1V$		± 0.4	± 1.5	mV
Input Bias Current	I_B	$V_{SS} - 0.1V \leq V_{CM} \leq V_{DD} + 0.1V$		± 10	± 50	nA
Input Offset Current	I_{OS}	$V_{SS} - 0.1V \leq V_{CM} \leq V_{DD} + 0.1V$		± 1	± 6	nA
Input Resistance	R_{IN}	$ V_{IN+} - V_{IN-} \leq 10\text{mV}$		4000		k Ω
Input Common-Mode Voltage Range	V_{CM}	Inferred from CMRR test	$V_{SS} - 0.1$		$V_{DD} + 0.1$	V
Common-Mode Rejection Ratio	CMRR	$V_{SS} - 0.1V \leq V_{CM} \leq V_{DD} + 0.1V$	65	80		dB
Power-Supply Rejection Ratio	PSRR	$2.5V \leq V_{DD} \leq 5.5V$	75	90		dB
Large-Signal Voltage Gain	A_v	$V_{SS} + 0.05V \leq V_{OUT} \leq V_{DD} - 0.05V$, $R_L = 100\text{k}\Omega$		120		dB
		$V_{SS} + 0.2V \leq V_{OUT} \leq V_{DD} - 0.2V$, $R_L = 2\text{k}\Omega$	95	110		
Output Voltage Swing High	V_{OH}	Specified as $V_{DD} - V_{OUT}$	$R_L = 100\text{k}\Omega$	1		mV
			$R_L = 2\text{k}\Omega$	35	60	
Output Voltage Swing Low	V_{OL}	Specified as $V_{OUT} - V_{SS}$	$R_L = 100\text{k}\Omega$	1		mV
			$R_L = 2\text{k}\Omega$	30	60	
Output Short-Circuit Current	$I_{OUT(SC)}$	$V_{DD} = +5.0V$	Sourcing	11		mA
			Sinking	30		
Output Leakage Current in Shutdown	$I_{OUT(SH)}$	Device in Shutdown Mode ($\overline{SHDN}_- = V_{SS}$), $V_{SS} \leq V_{OUT} \leq V_{DD}$ (Note 2)		± 0.01	± 0.5	μA
\overline{SHDN}_- Logic Low	V_{IL}	(Note 2)		$0.3 \times V_{DD}$		V
\overline{SHDN}_- Logic High	V_{IH}	(Note 2)	$0.7 \times V_{DD}$			V
\overline{SHDN}_- Input Current	I_L/I_H	$V_{SS} \leq \overline{SHDN}_- \leq V_{DD}$ (Note 2)		0.5	50	nA

Ultra-Small, Rail-to-Rail I/O with Disable, Single-/Dual-Supply, Low-Power Op Amps

MAX4245/MAX4246/MAX4247

ELECTRICAL CHARACTERISTICS (continued)

($V_{DD} = +2.7V$, $V_{SS} = 0V$, $V_{CM} = 0V$, $V_{OUT} = V_{DD} / 2$, R_L connected from OUT to $V_{DD} / 2$, $\overline{SHDN}_- = V_{DD}$ (MAX4245/MAX4247 only), $T_A = +25^\circ C$, unless otherwise noted.) (Note 1)

PARAMETER	SYMBOL	CONDITIONS	MIN	TYP	MAX	UNITS
Gain-Bandwidth Product	GBW			1.0		MHz
Phase Margin	ϕ_M			70		degrees
Gain Margin	G_M			20		dB
Slew Rate	SR			0.4		V/ μ s
Input Voltage-Noise Density	e_n	$f = 10kHz$		52		nV/ \sqrt{Hz}
Input Current-Noise Density	i_n	$f = 10kHz$		0.1		pA/ \sqrt{Hz}
Capacitive-Load Stability	C_{LOAD}	$A_v = 1$ (Note 3)			470	pF
Shutdown Delay Time	$t_{(SH)}$	(Note 2)		3		μ s
Enable Delay Time	$t_{(EN)}$	(Note 2)		4		μ s
Power-On Time	t_{ON}			4		μ s
Input Capacitance	C_{IN}			2.5		pF
Total Harmonic Distortion	THD	$f = 10kHz$, $V_{OUT} = 2V_{p-p}$, $A_v = +1$, $V_{DD} = +5.0V$, Load = $100k\Omega$ to $V_{DD}/2$		0.01		%
Settling Time to 0.01%	t_S	$V_{OUT} = 4V$ step, $V_{DD} = +5.0V$, $A_v = +1$		10		μ s

ELECTRICAL CHARACTERISTICS

($V_{DD} = +2.7V$, $V_{SS} = 0V$, $V_{CM} = 0V$, $V_{OUT} = V_{DD} / 2$, R_L connected from OUT to $V_{DD} / 2$, $\overline{SHDN}_- = V_{DD}$ (MAX4245/MAX4247 only), $T_A = -40^\circ C$ to $+125^\circ C$, unless otherwise noted.) (Note 1)

PARAMETER	SYMBOL	CONDITIONS	MIN	TYP	MAX	UNITS
Supply Voltage Range	V_{DD}	Inferred from PSRR test	2.5		5.5	V
Supply Current (Per Amplifier)	I_{DD}	$V_{DD} = +2.7V$			800	μ A
Supply Current in Shutdown	$I_{\overline{SHDN}_-}$	$\overline{SHDN}_- = V_{SS}$ (Note 2)			1	μ A
Input Offset Voltage	V_{OS}	$V_{SS} \leq V_{CM} \leq V_{DD}$ (Note 4)			± 3.0	mV
Input Offset Voltage Drift	TCV_{OS}	$V_{SS} \leq V_{CM} \leq V_{DD}$ (Note 4)		± 2		$\mu V/^\circ C$
Input Bias Current	I_B	$V_{SS} \leq V_{CM} \leq V_{DD}$ (Note 4)			± 100	nA
Input Offset Current	I_{OS}	$V_{SS} \leq V_{CM} \leq V_{DD}$ (Note 4)			± 10	nA
Input Common-Mode Voltage Range	V_{CM}	Inferred from CMRR test (Note 4)	V_{SS}		V_{DD}	V
Common-Mode Rejection Ratio	CMRR	$V_{SS} \leq V_{CM} \leq V_{DD}$ (Note 4)	60			dB
Power-Supply Rejection Ratio	PSRR	$2.5V \leq V_{DD} \leq 5.5V$	70			dB
Large-Signal Voltage Gain	A_v	$V_{SS} + 0.2V \leq V_{OUT} \leq V_{DD} - 0.2V$, $R_L = 2k\Omega$	85			dB
Output Voltage Swing High	V_{OH}	Specified as $V_{DD} - V_{OUT}$, $R_L = 2k\Omega$			90	mV
Output Voltage Swing Low	V_{OL}	Specified as $V_{OUT} - V_{SS}$, $R_L = 2k\Omega$			90	mV
Output Leakage Current in Shutdown	$I_{OUT(SH)}$	Device in Shutdown Mode ($\overline{SHDN}_- = V_{SS}$), $V_{SS} \leq V_{OUT} \leq V_{DD}$ (Note 3)			± 1.0	μ A

Ultra-Small, Rail-to-Rail I/O with Disable, Single-/Dual-Supply, Low-Power Op Amps

ELECTRICAL CHARACTERISTICS (continued)

($V_{DD} = +2.7V$, $V_{SS} = 0V$, $V_{CM} = 0V$, $V_{OUT} = V_{DD} / 2$, R_L connected from OUT to $V_{DD} / 2$, $\overline{SHDN_} = V_{DD}$ (MAX4245/MAX4247 only), $T_A = -40^\circ C$ to $+125^\circ C$, unless otherwise noted.) (Note 1)

PARAMETER	SYMBOL	CONDITIONS	MIN	TYP	MAX	UNITS
$\overline{SHDN_}$ Logic Low	V_{IL}	(Note 2)			$0.3 \times V_{DD}$	V
$\overline{SHDN_}$ Logic High	V_{IH}	(Note 2)	$0.7 \times V_{DD}$			V
$\overline{SHDN_}$ Input Current	I_L/I_H	$V_{SS} \leq \overline{SHDN_} \leq V_{DD}$ (Notes 2, 3)			100	nA

Note 1: Specifications are 100% tested at $T_A = +25^\circ C$. All temperature limits are guaranteed by design.

Note 2: Shutdown mode is only available in MAX4245 and MAX4247.

Note 3: Guaranteed by design, not production tested.

Note 4: For $-40^\circ C$ to $+85^\circ C$, Input Common-Mode Range is $V_{SS} - 0.1V \leq V_{CM} \leq V_{DD} + 0.1V$.

Typical Operating Characteristics

($V_{DD} = 2.7V$, $V_{SS} = V_{CM} = 0V$, $V_{OUT} = V_{DD} / 2$, no load, $T_A = +25^\circ C$, unless otherwise noted.)

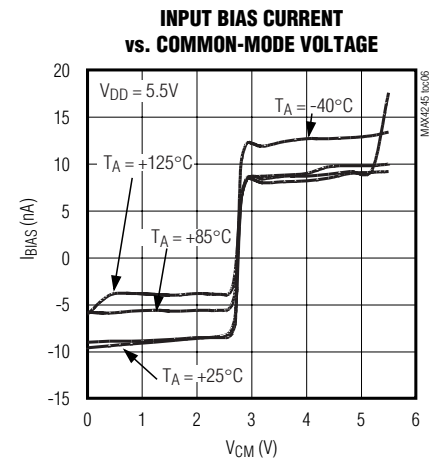
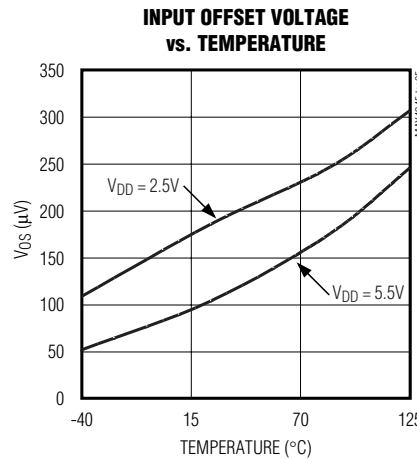
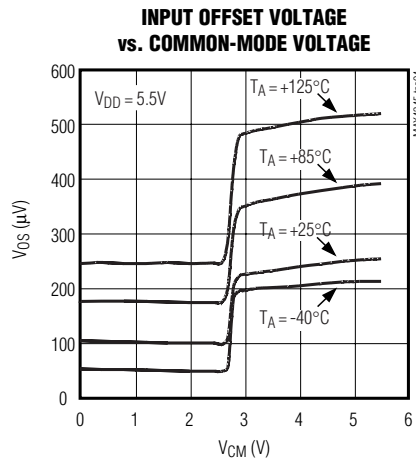
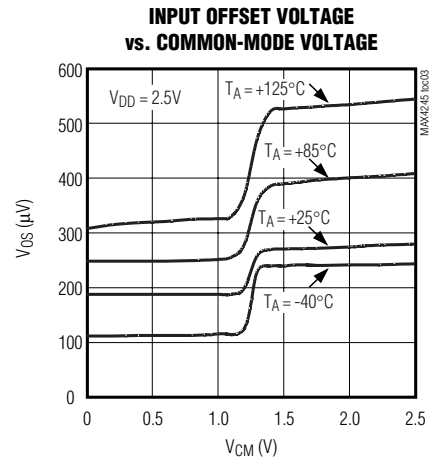
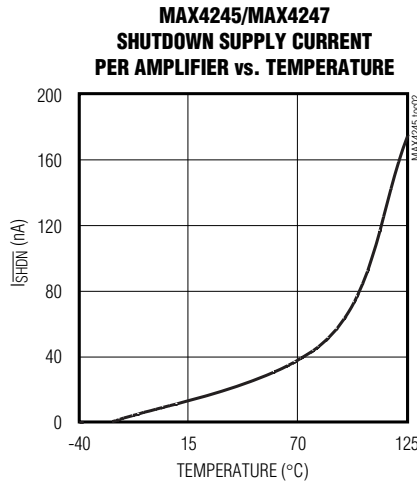
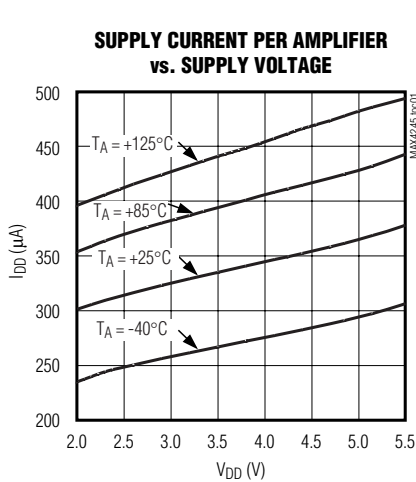

Ultra-Small, Rail-to-Rail I/O with Disable, Single-/Dual-Supply, Low-Power Op Amps

Typical Operating Characteristics (continued)

($V_{DD} = 2.7V$, $V_{SS} = V_{CM} = 0V$, $V_{OUT} = V_{DD} / 2$, no load, $T_A = +25^\circ C$, unless otherwise noted.)

MAX4245/MAX4246/MAX4247

OUTPUT SOURCE CURRENT vs. OUTPUT VOLTAGE

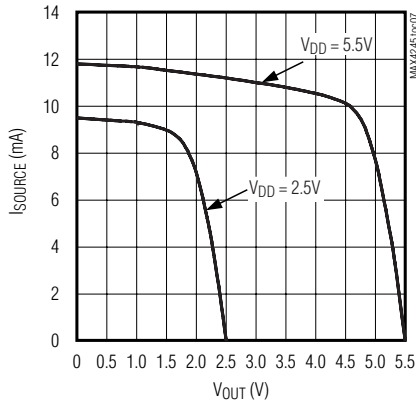

OUTPUT SINK CURRENT vs. OUTPUT VOLTAGE

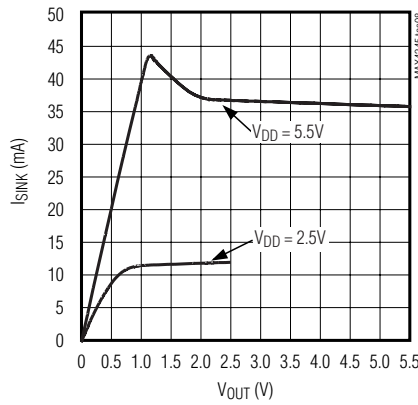

OUTPUT SWING HIGH vs. TEMPERATURE

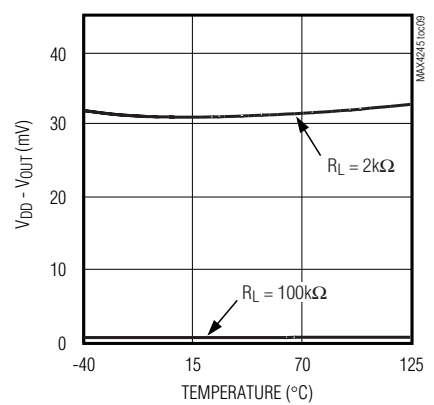

OUTPUT SWING LOW vs. TEMPERATURE

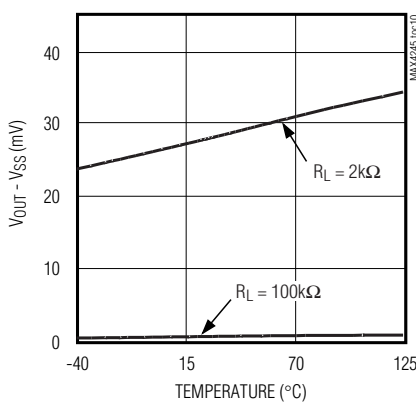

CROSSTALK vs. FREQUENCY

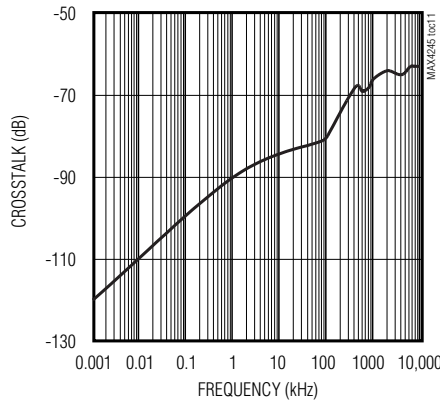

POWER-SUPPLY REJECTION RATIO vs. FREQUENCY

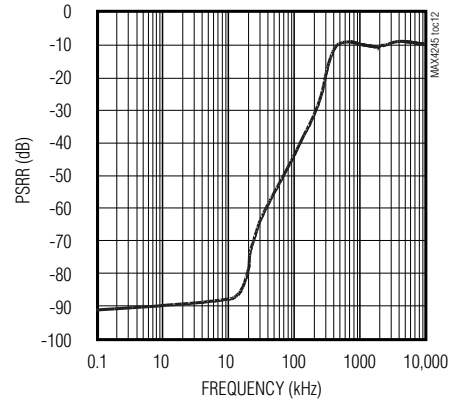

TOTAL HARMONIC DISTORTION PLUS NOISE vs. INPUT FREQUENCY

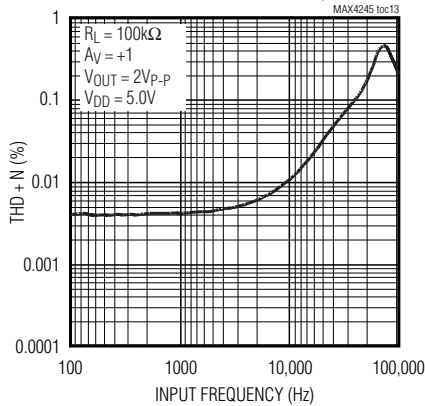

TOTAL HARMONIC DISTORTION PLUS NOISE vs. AMPLITUDE

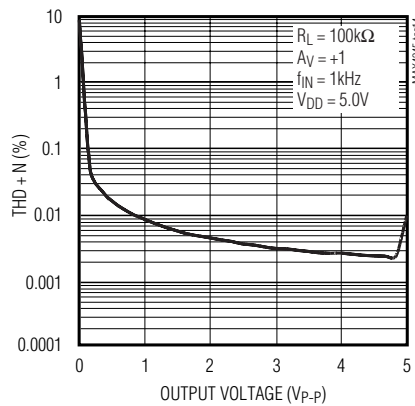

GAIN AND PHASE vs. FREQUENCY

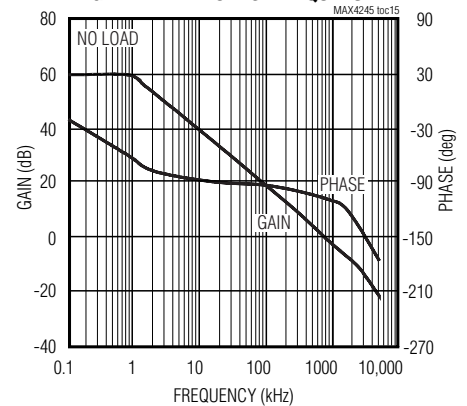

Ultra-Small, Rail-to-Rail I/O with Disable, Single-/Dual-Supply, Low-Power Op Amps

Typical Operating Characteristics (continued)

($V_{DD} = 2.7V$, $V_{SS} = V_{CM} = 0V$, $V_{OUT} = V_{DD} / 2$, no load, $T_A = +25^\circ C$, unless otherwise noted.)

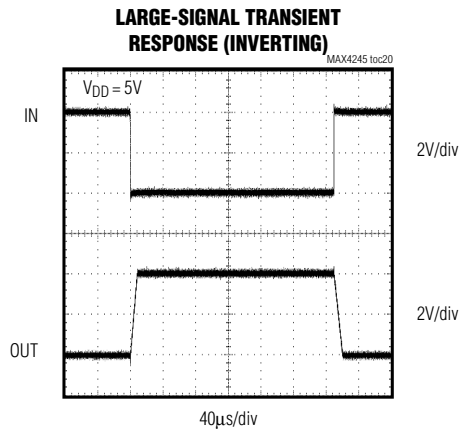
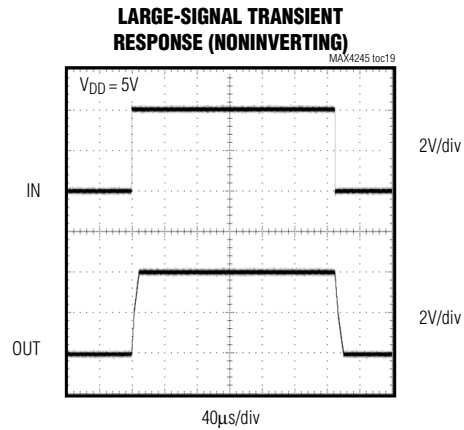
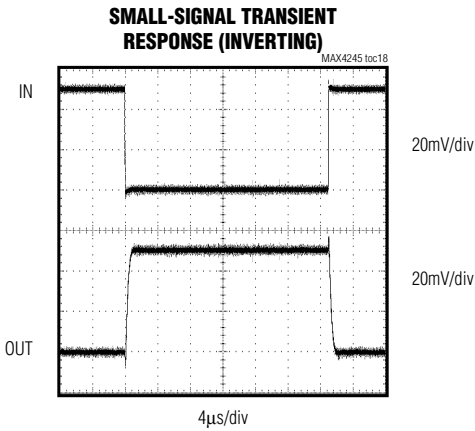
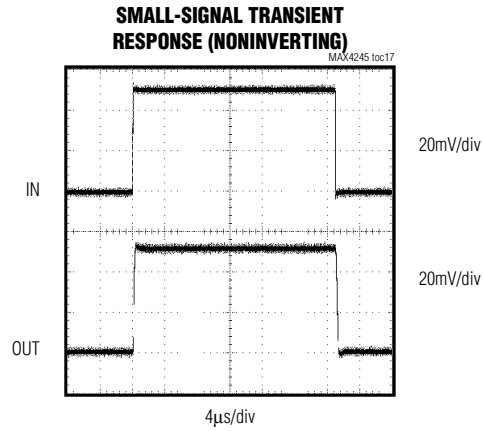
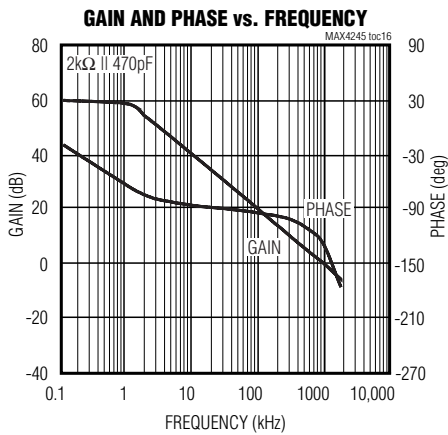

Ultra-Small, Rail-to-Rail I/O with Disable, Single-/Dual-Supply, Low-Power Op Amps

Pin Description

PIN			NAME	FUNCTION
MAX4245	MAX4246	MAX4247		
1	—	—	IN+	Noninverting Input
2	4	4	V _{SS}	Ground or Negative Supply
3	—	—	IN-	Inverting Input
4	—	—	OUT	Amplifier Output
5	—	—	$\overline{\text{SHDN}}$	Shutdown
6	8	10	V _{DD}	Positive Supply
—	1	1	OUTA	Amplifier Output Channel A
—	2	2	INA-	Inverting Input Channel A
—	3	3	INA+	Noninverting Input Channel A
—	5	7	INB+	Noninverting Input Channel B
—	6	8	INB-	Inverting Input Channel B
—	7	9	OUTB	Amplifier Output Channel B
—	—	5	$\overline{\text{SHDNA}}$	Shutdown Channel A
—	—	6	$\overline{\text{SHDNB}}$	Shutdown Channel B

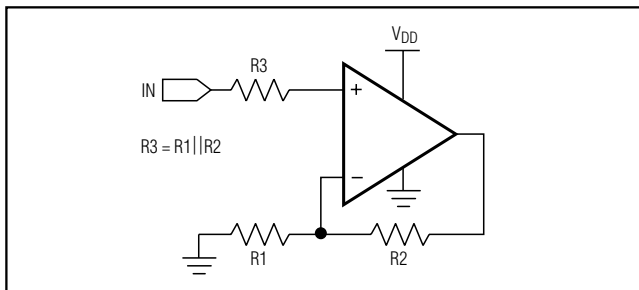

Figure 1a. Minimizing Offset Error Due to Input Bias Current (Noninverting)

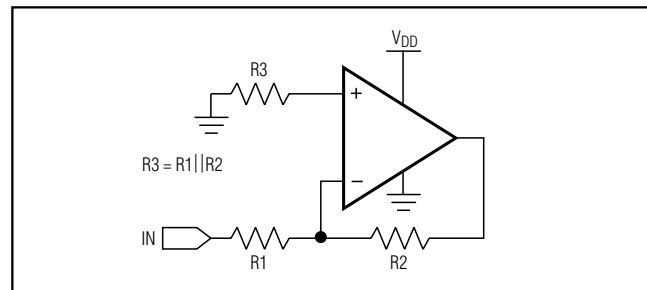

Figure 1b. Minimizing Offset Error Due to Input Bias Current (Inverting)

Detailed Description

Rail-to-Rail Input Stage

The MAX4245/MAX4246/MAX4247 have rail-to-rail input and output stages that are specifically designed for low-voltage, single-supply operation. The input stage consists of composite NPN and PNP differential stages, which operate together to provide a common-mode range extending to both supply rails. The crossover region of these two pairs occurs halfway between V_{DD} and V_{SS}. The input offset voltage is typically $\pm 400\mu\text{V}$. Low-operating supply voltage, low supply current and rail-to-rail outputs make this family of operational amplifiers an excellent choice for precision or general-purpose, low-voltage, battery-powered systems.

Since the input stage consists of NPN and PNP pairs, the input bias current changes polarity as the common-

mode voltage passes through the crossover region. Match the effective impedance seen by each input to reduce the offset error caused by input bias currents flowing through external source impedance (Figures 1a and 1b).

The combination of high-source impedance plus input capacitance (amplifier input capacitance plus stray capacitance) creates a parasitic pole that can produce an underdamped signal response. Reducing input capacitance or placing a small capacitor across the feedback resistor improves response in this case.

The MAX4245/MAX4246/MAX4247 family's inputs are protected from large differential input voltages by internal $5.3\text{k}\Omega$ series resistors and back-to-back triple-diode stacks across the inputs (Figure 2). For differential-input voltages much less than 2.1V (triple-diode drop),

Ultra-Small, Rail-to-Rail I/O with Disable, Single-/Dual-Supply, Low-Power Op Amps

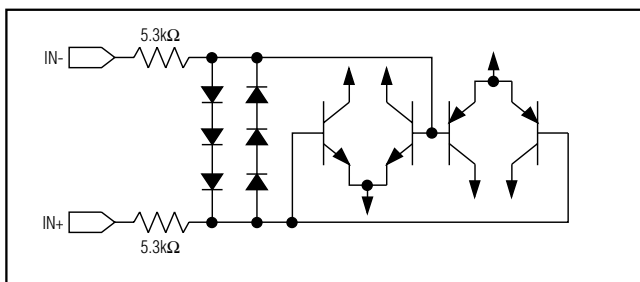

Figure 2. Input Protection Circuit

input resistance is typically $4M\Omega$. For differential voltages greater than 2.1V, input resistance is around $10.6k\Omega$, and the input bias current can be approximated by the following equation:

$$I_B = (V_{DIFF} - 2.1V) / 10.6k\Omega$$

In the region where the differential input voltage approaches 2.1V, the input resistance decreases exponentially from $4M\Omega$ to $10.6k\Omega$ as the diodes begin to conduct. It follows that the bias current increases with the same curve.

In unity-gain configuration, high slew-rate input signals may capacitively couple to the output through the triple-diode stacks.

Rail-to-Rail Output Stage

The MAX4245/MAX4246/MAX4247 can drive a $2k\Omega$ load and still typically swing within 35mV of the supply rails. Figure 3 shows the output voltage swing of the MAX4245 configured with $A_V = -1V/V$.

Applications Information

Power-Supply Considerations

The MAX4245/MAX4246/MAX4247 operate from a single +2.5V to +5.5V supply (or dual $\pm 1.25V$ to $\pm 2.75V$ supplies) and consume only $320\mu A$ of supply current per amplifier. A 90dB power-supply rejection ratio allows the amplifiers to be powered directly off a decaying battery voltage, simplifying design and extending battery life.

Power-Up

The MAX4245/MAX4246/MAX4247 output typically settles within $4\mu s$ after power-up. Figure 4 shows the output voltage on power-up and power-down.

Shutdown Mode

The MAX4245/MAX4247 feature a low-power shutdown mode. When \overline{SHDN} is pulled low, the supply current drops to 50nA per amplifier, the amplifier is disabled, and the output enters a high-impedance state. Pulling

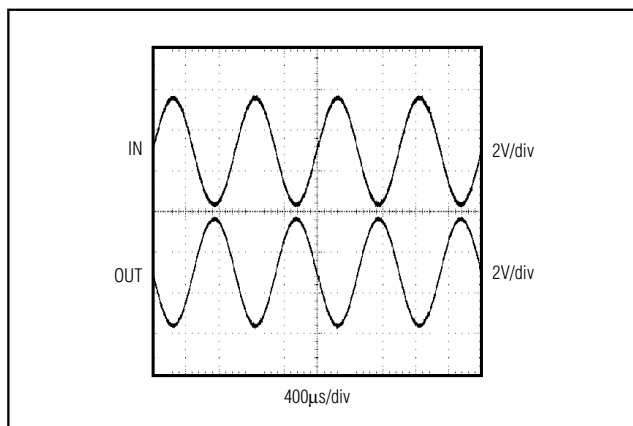

Figure 3. Rail-to-Rail Input/Output Voltage Range

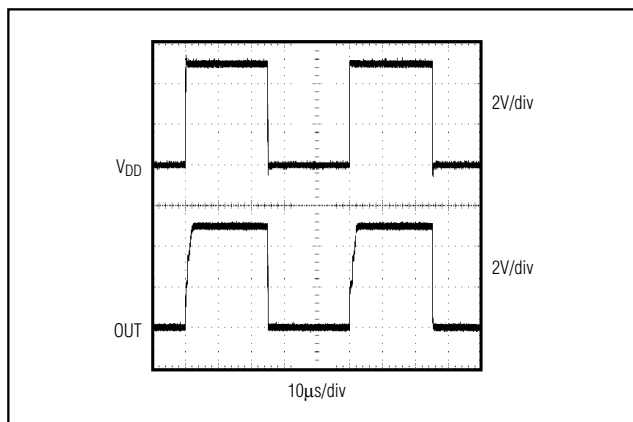

Figure 4. Power-Up/Power-Down Waveform

\overline{SHDN} high enables the amplifier. Figure 5 shows the MAX4245/MAX4247's shutdown waveform.

Due to the output leakage currents of three-state devices and the small internal pullup current for \overline{SHDN} , do not let the \overline{SHDN} float. Floating \overline{SHDN} may result in indeterminate logic levels, and could adversely affect op amp operation. The logic threshold for \overline{SHDN} is referred to V_{SS} . When using dual supplies, pull \overline{SHDN} to V_{SS} , not GND, to shut down the op amp.

Driving Capacitive Loads

The MAX4245/MAX4246/MAX4247 are unity-gain stable for loads up to $470pF$. Applications that require greater capacitive drive capability should use an isolation resistor between the output and the capacitive load

Ultra-Small, Rail-to-Rail I/O with Disable, Single-/Dual-Supply, Low-Power Op Amps

MAX4245/MAX4246/MAX4247

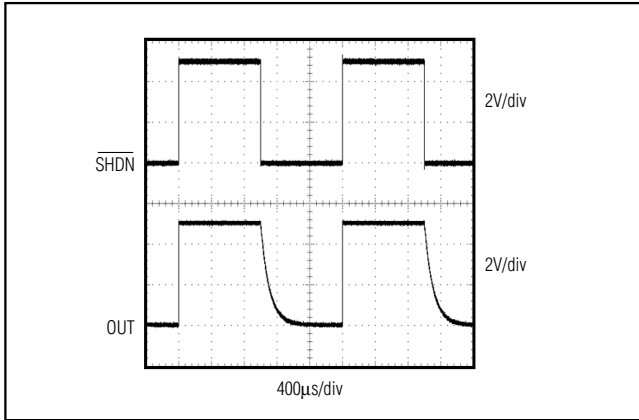

Figure 5. Shutdown Waveform

(Figures 6a, 6b, 6c). Note that this alternative results in a loss of gain accuracy because R_{ISO} forms a voltage divider with the R_{LOAD} .

Power-Supply Bypassing and Layout

The MAX4245/MAX4246/MAX4247 family operates from either a single +2.5V to +5.5V supply or dual $\pm 1.25V$ to $\pm 2.75V$ supplies. For single-supply operation, bypass the power supply with a 100nF capacitor to V_{SS} (in this case GND). For dual-supply operation, both the V_{DD} and the V_{SS} supplies should be bypassed to ground with separate 100nF capacitors.

Good PC board layout techniques optimize performance by decreasing the amount of stray capacitance at the op amp's inputs and output. To decrease stray capacitance, minimize trace lengths and widths by placing external components as close to the device as possible. Use surface-mount components when possible.

Pin Configurations (continued)

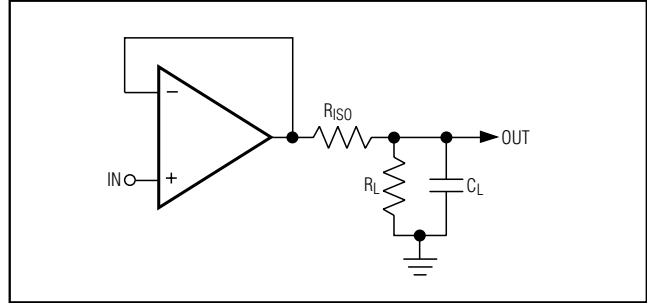
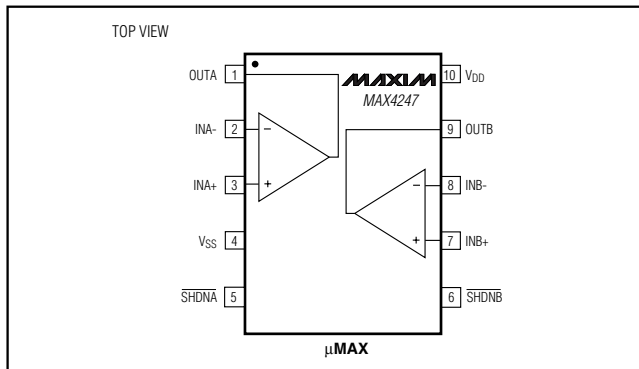

Figure 6a. Using a Resistor to Isolate a Capacitive Load from the Op Amp

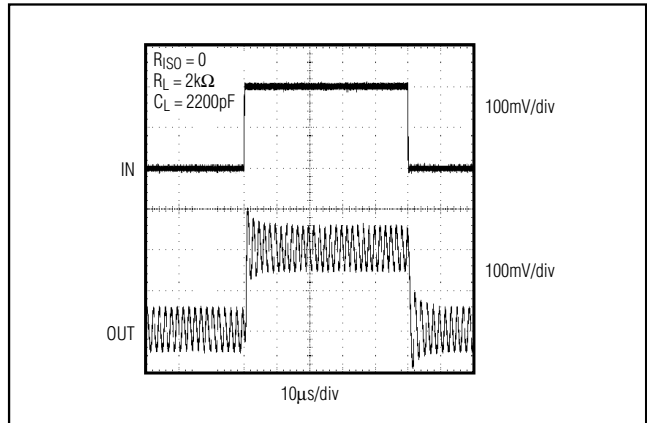

Figure 6b. Pulse Response Without Isolating Resistor

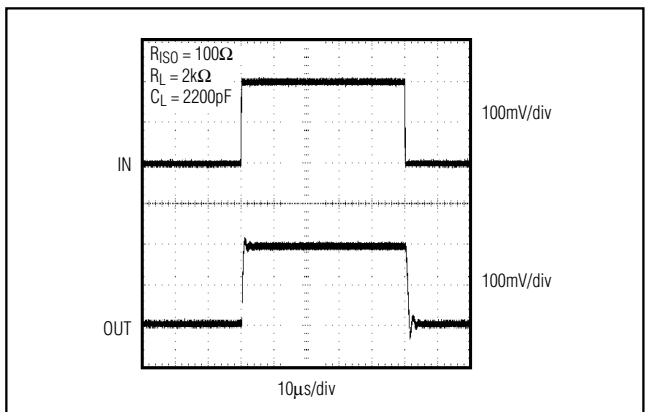

Figure 6c. Pulse Response With Isolating Resistor

Chip Information

MAX4245 TRANSISTOR COUNT: 207
 MAX4246/MAX4247 TRANSISTOR COUNT: 414
 PROCESS: BiCMOS

Ultra-Small, Rail-to-Rail I/O with Disable, Single-/Dual-Supply, Low-Power Op Amps

Package Information

(The package drawing(s) in this data sheet may not reflect the most current specifications. For the latest package outline information go to www.maxim-ic.com/packages.)

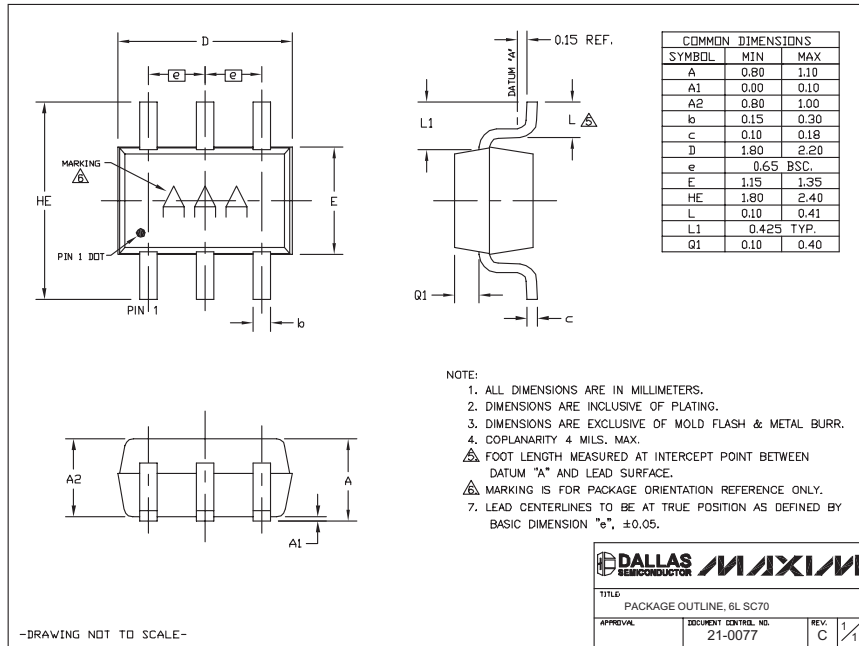

SC70 6L EFS

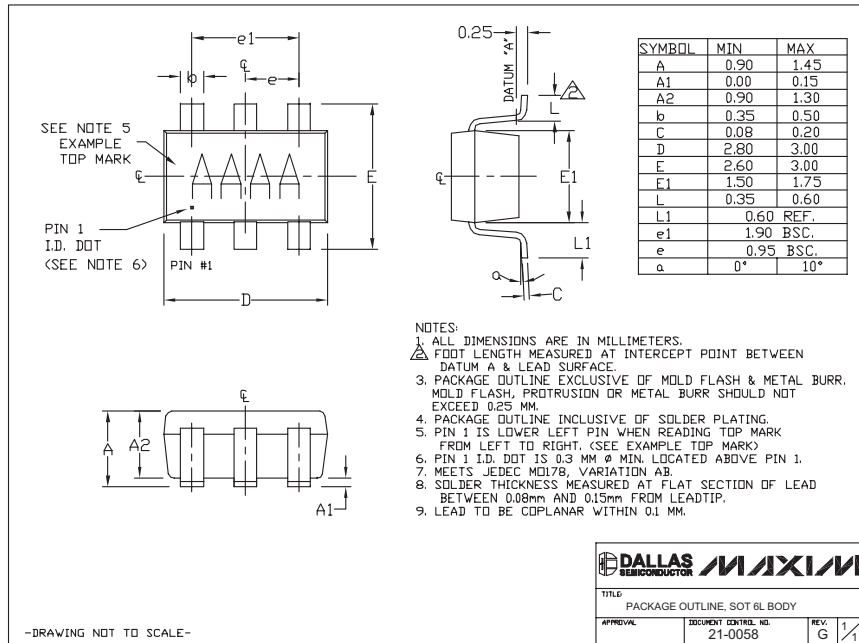

6L SOT EFS

Ultra-Small, Rail-to-Rail I/O with Disable, Single-/Dual-Supply, Low-Power Op Amps

Package Information (continued)

(The package drawing(s) in this data sheet may not reflect the most current specifications. For the latest package outline information go to www.maxim-ic.com/packages.)

MAX4245/MAX4246/MAX4247

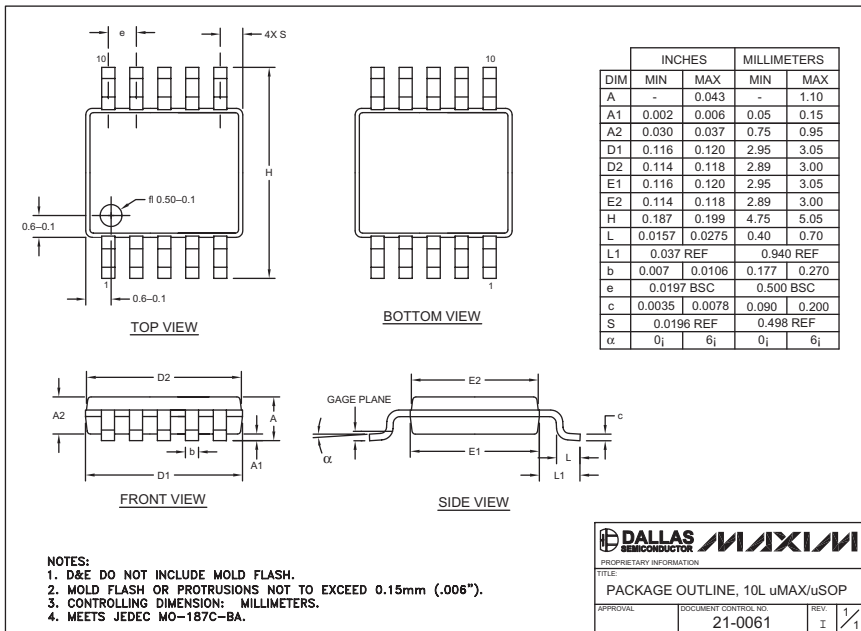
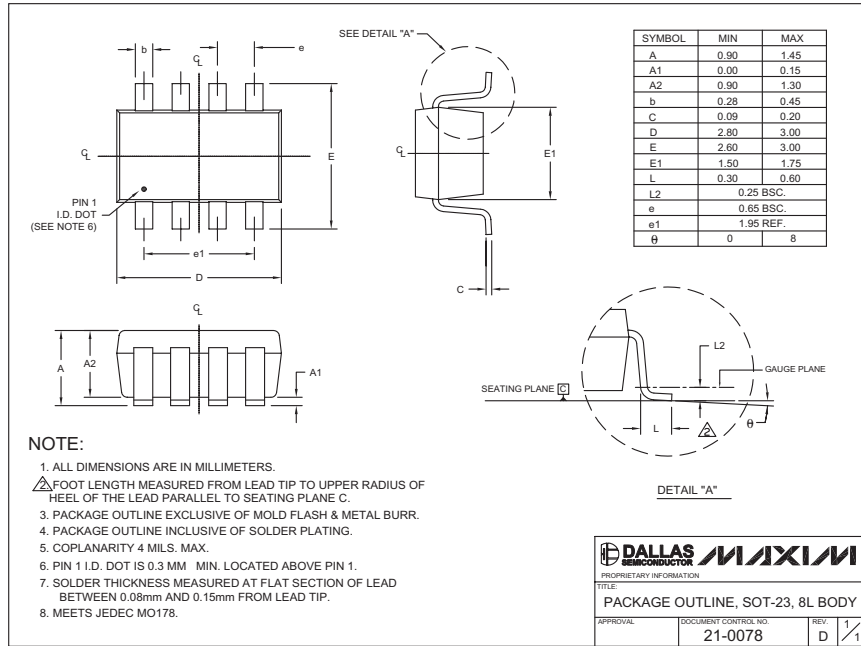

Ultra-Small, Rail-to-Rail I/O with Disable, Single-/Dual-Supply, Low-Power Op Amps

Package Information (continued)

(The package drawing(s) in this data sheet may not reflect the most current specifications. For the latest package outline information go to www.maxim-ic.com/packages.)

SOICN .EPS

TOP VIEW

FRONT VIEW

SIDE VIEW

DIM	INCHES		MILLIMETERS	
	MIN	MAX	MIN	MAX
A	0.053	0.069	1.35	1.75
A1	0.004	0.010	0.10	0.25
B	0.014	0.019	0.35	0.49
C	0.007	0.010	0.19	0.25
e	0.050 BSC		1.27 BSC	
E	0.150	0.157	3.80	4.00
H	0.228	0.244	5.80	6.20
L	0.016	0.050	0.40	1.27

VARIATIONS:

DIM	INCHES		MILLIMETERS		N	MS012
	MIN	MAX	MIN	MAX		
D	0.189	0.197	4.80	5.00	8	AA
D	0.337	0.344	8.55	8.75	14	AB
D	0.386	0.394	9.80	10.00	16	AC

NOTES:

1. D&E DO NOT INCLUDE MOLD FLASH.
2. MOLD FLASH OR PROTRUSIONS NOT TO EXCEED 0.15mm (.006").
3. LEADS TO BE COPLANAR WITHIN 0.10mm (.004").
4. CONTROLLING DIMENSION: MILLIMETERS.
5. MEETS JEDEC MS012.
6. N = NUMBER OF PINS.

DALLAS SEMICONDUCTOR **MAXIM**

PROPRIETARY INFORMATION

TITLE: PACKAGE OUTLINE, .150" SOIC

APPROVAL	DOCUMENT CONTROL NO. 21-0041	REV. B	1/1
----------	---------------------------------	-----------	-----

Maxim cannot assume responsibility for use of any circuitry other than circuitry entirely embodied in a Maxim product. No circuit patent licenses are implied. Maxim reserves the right to change the circuitry and specifications without notice at any time.

12 _____ **Maxim Integrated Products, 120 San Gabriel Drive, Sunnyvale, CA 94086 408-737-7600**